

**COMANDO A PARETE
WALL CONTROL
COMMANDE MURALE**

T-MB2
9066994E
9066994ESW



MANUALE DI INSTALLAZIONE, USO E MANUTENZIONE
INSTALLATION, USE AND MAINTENANCE MANUAL
MANUEL D'INSTALLATION, D'UTILISATION ET D'ENTRETIEN



01/2024
Cod. 4050329

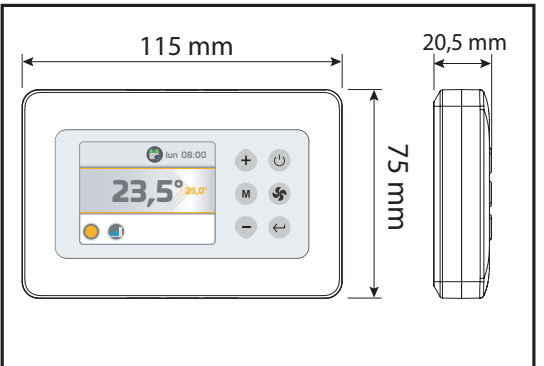
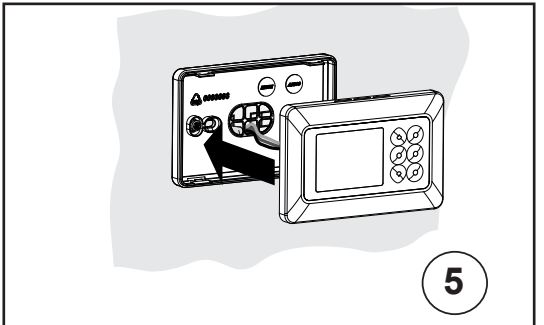
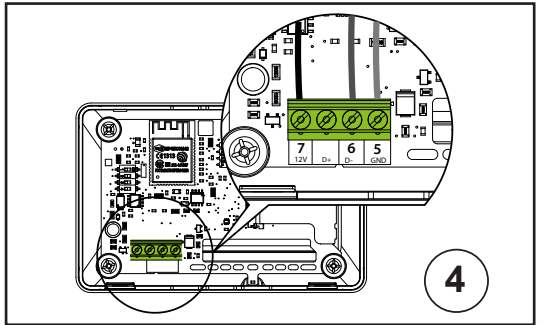
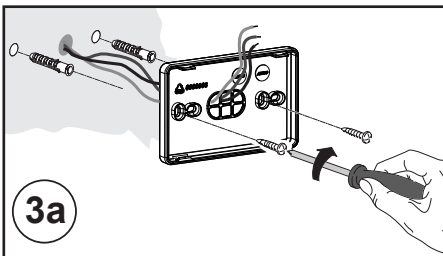
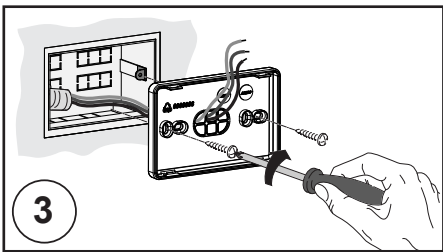
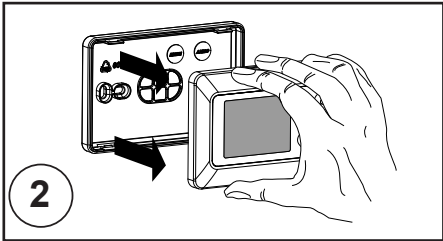
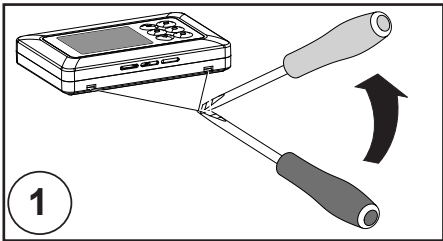
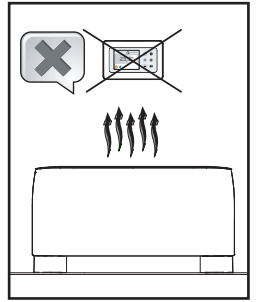
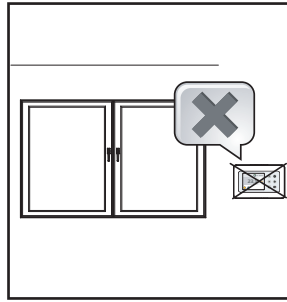
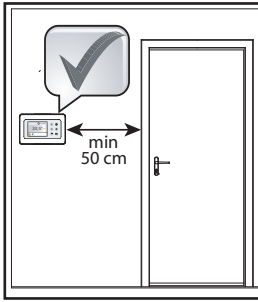
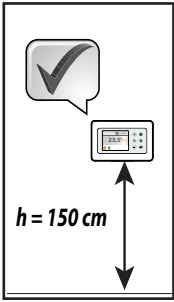

COLLEGAMENTI ELETTRICI DEL COMANDO

Il pannello comandi deve essere collegato elettricamente alla scheda di potenza posta all'interno dell'apparecchiatura elettrica dell'unità rispettando la corrispondenza della numerazione comune ad entrambe le schede.

Utilizzare 3 conduttori con sezione 0,5 mm².

NOTA: La lunghezza del cavo di collegamento non deve essere superiore ai 20 metri.

ATTENZIONE: il comando deve essere usato esclusivamente negli abbinamenti alle unità di controllo previsti dal fabbricante e riportati nella documentazione del fabbricante.

La conformità del comando alle norme e direttive di sicurezza applicabili è garantita solo ed esclusivamente secondo tali abbinamenti.

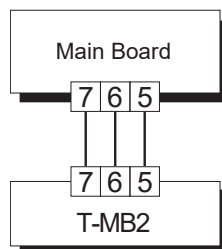

IMPOSTAZIONE DIP DI CONFIGURAZIONE

DEFAULT

DIP 1 = OFF DIP 3 = ON
DIP 2 = OFF DIP 4 = OFF

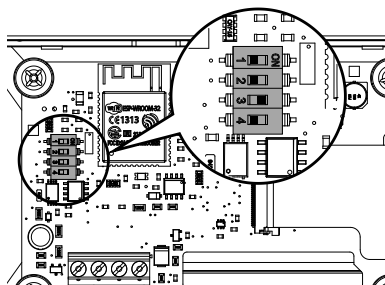



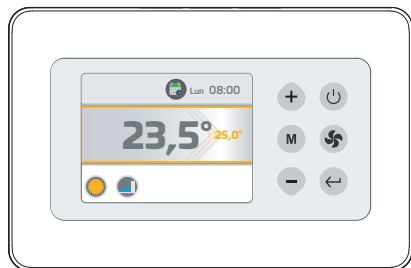

FUNZIONE	DIP1	DIP2	DIP3	DIP4
T-MB2 - unità con scheda MB	OFF	OFF	ON	OFF
T-MB2 - unità con scheda AU	OFF	ON	ON	OFF
T-MB2 - unità LAMA ARIA	ON	OFF	ON	OFF

PANORAMICA COMANDO

TASTI



-  On/Off (Stand-by)
-  Mode
-  Enter/Return
-  Ventilazione
-  Incremento/Decremento

DISPLAY



- A. Visualizzazione delle funzioni attive
- B. Temperatura Ambiente
- C. Identificativo modalità:
 - Estate/Raffrescamento = Blu
 - Inverno/Riscaldamento = Arancione

- D. Set modalità Estate
- E. Stato in richiesta modalità Estate
- F. Set modalità Inverno
- G. Stato in richiesta modalità Inverno
- H. Visualizzazione Allarmi
- I. Visualizzazione in versione +/-3 (solo MB)

ICONE

	Mode Estate - Raffrescamento		Programmazione Timer		Velocità MINIMA (FAN 3 gradini)
	Mode Inverno - Riscaldamento		Impostazione Orologio		Velocità MEDIA (FAN 3 gradini)
	Mode Automatico		Menù Installatore		Velocità MASSIMA (FAN 3 gradini)
	Mode Ventilazione		Informazioni		Velocità AUTOMATICA
	- Menù attivazione Flap Swing - Segnalazione Swing Attivo		Diagnostica Visualizzazione stato		Velocità LINEARE scala 1-10 Volt (se disponibile)
	- Menù attivazione IAQ - Segnalazione Filtro IAQ Attivo		Presenza Allarme		Stand-by
	- Menù attivazione Night mode - Segnalazione Night mode Attivo		Segnalazione Ciclo Antistratificazione Attivo		Menù Lingua
	- Menù attivazione Timer		Segnalazione Resistenza Attiva		Segnalazione ON/OFF remoto attivato
	- Attivazione Timer 1,2 o 3 - Segnalazione Timer Attivo (1,2 o 3)		Segnalazione Resistenza Attiva Potenza Max		Segnalazione Contatto Finestra attivato (disponibile solo con schede MB)
	- Attivazione Timer APP - Segnalazione Timer APP Attivo		- Timer non attivo		

UTILIZZO DEI TASTI PER LA NAVIGAZIONE

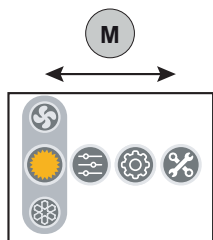

Spostamento orizzontale:

per spostamenti da sinistra a destra

tra i menù utilizzare il tasto **M**.

Ad ogni pressione avviene uno spostamento

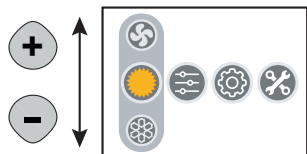

Spostamento verticale:

per spostamenti dall'alto al basso

nei menù per la scelta delle funzioni utilizzare i tasti **+** **-**.

Ad ogni pressione avviene uno spostamento

Conferma:



per confermare la scelta del menù o della

funzione utilizzare il tasto .

PANORAMICA DEI MENU'

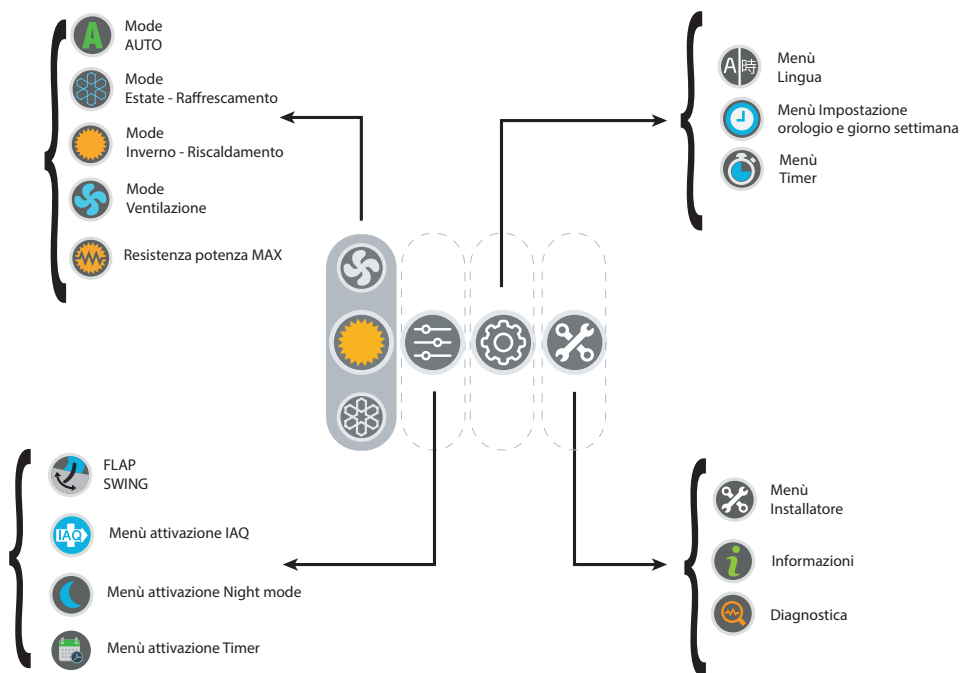

FUNZIONALITA' PRIMARIE

ON/OFF

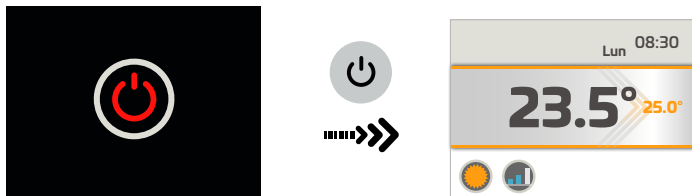

Impostazione MODE

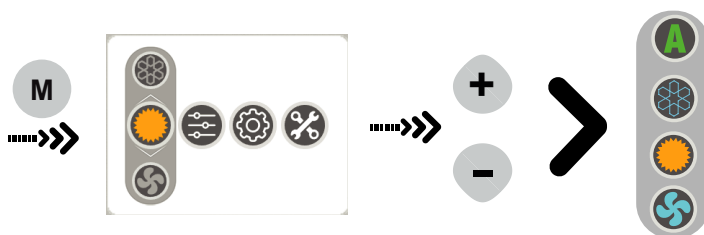

Impostazione SET

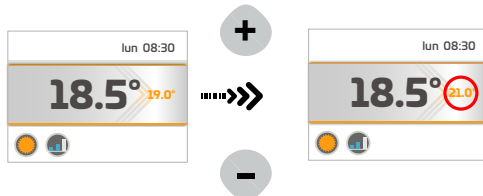

Impostazione VELOCITA'

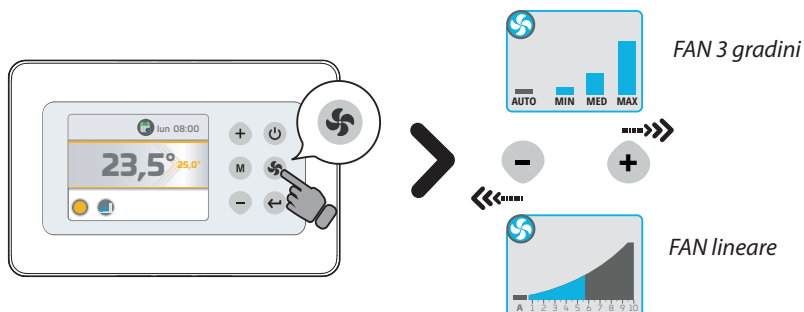

IMPOSTAZIONE OROLOGIO

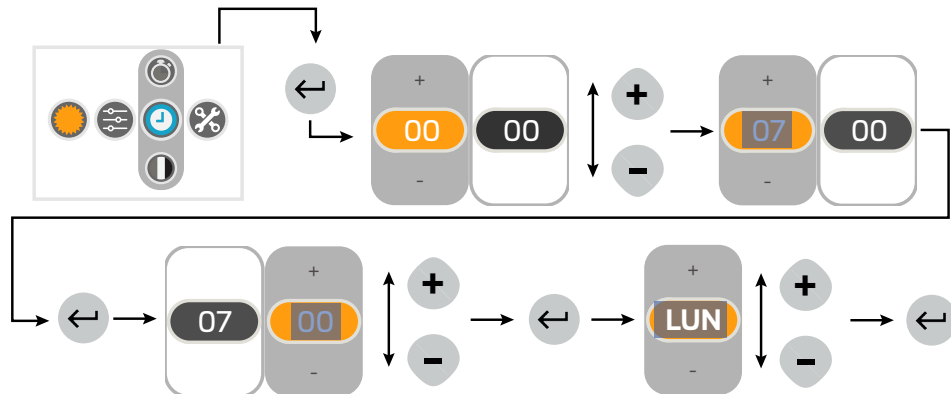

TIMER - Attivazione

Sono disponibili 4 programmi TIMER attivabili a scelta: TIMER1, TIMER 2, TIMER 3, TIMER APP.

TIMER 1, TIMER 2, TIMER 3: destinati ad impostazione sul comando; seguire le istruzioni di seguito riportate per impostazione e attivazione dei 3 programmi.

TIMER APP: destinato a registrare il programma TIMER impostato tramite APP (se disponibile).

Per scegliere quale programma TIMER (precedentemente configurato) attivare, seguire la istruzione sotto riportata:

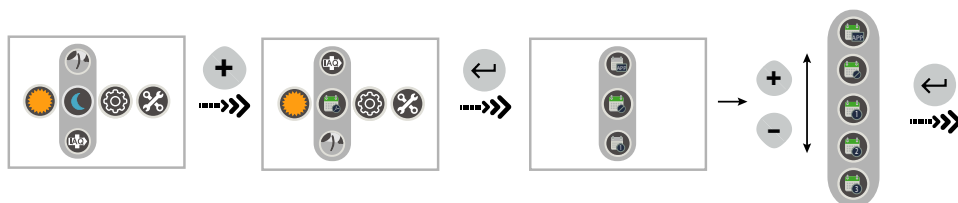

TIMER - Configurazione Programma

Tutti i timer escono da fabbrica non configurati

IMPORTANTE: per poter eseguire la configurazione di un programma TIMER è necessario eseguirne prima l'attivazione. Nel caso in cui si esegua la configurazione senza aver precedentemente attivato un programma, la configurazione verrà salvata automaticamente nel programma TIMER 1

Per configurare uno o più programmi TIMER 1,2,3:

- 1) attivare il programma che si vuole configurare tramite il menu di attivazione.
- 2) accedere al menu configurazione seguendo le istruzioni sotto riportate:

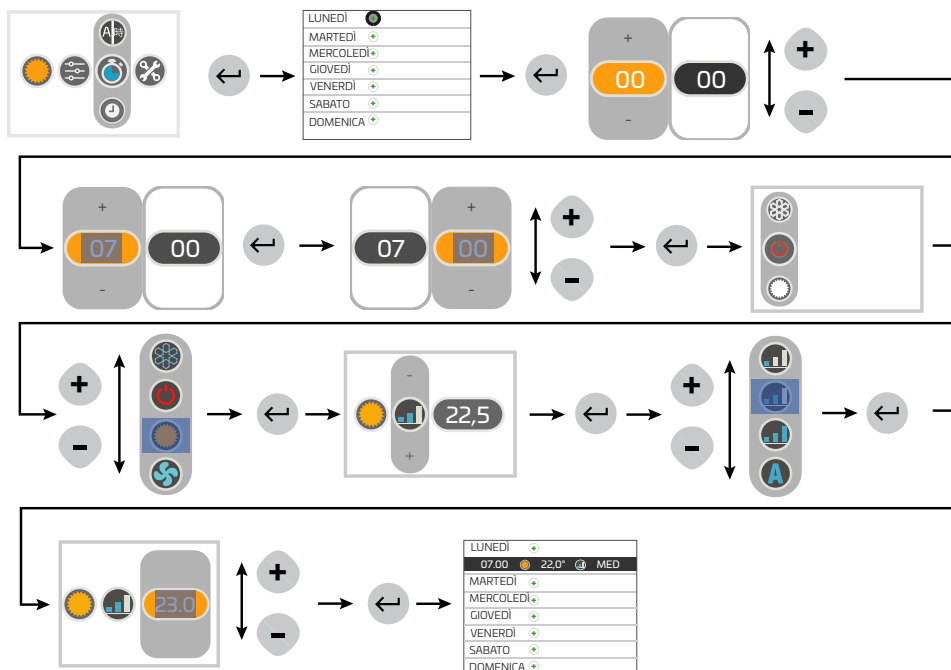

IMPORTANTE! Prima di modificare o eliminare un programma **TIMER** occorre che sia attivato nel menù "Attivazione" (vedi capitolo dedicato).

TIMER - Modifica Programma

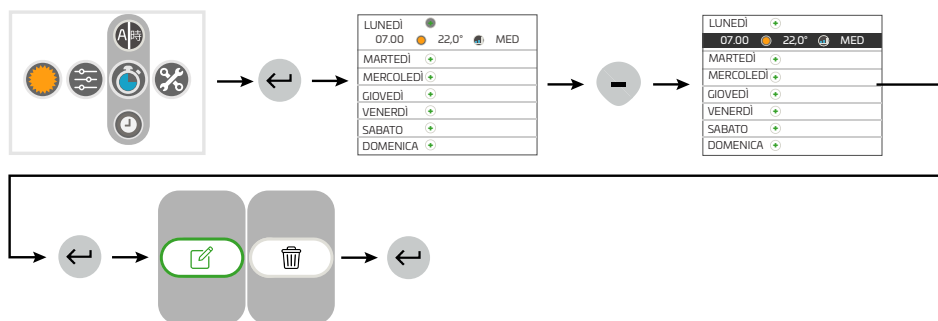

TIMER - Eliminazione Programma

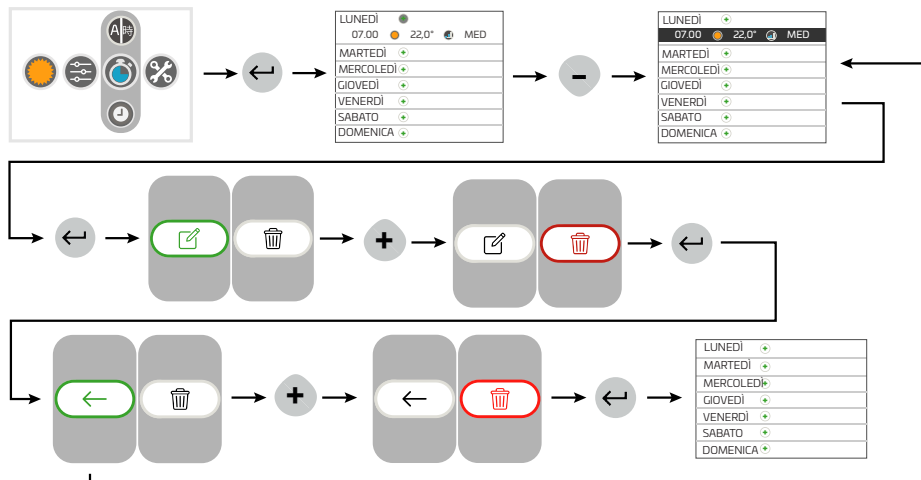

FUNZIONALITA' SECONDARIE

Attivazione Filtro IAQ

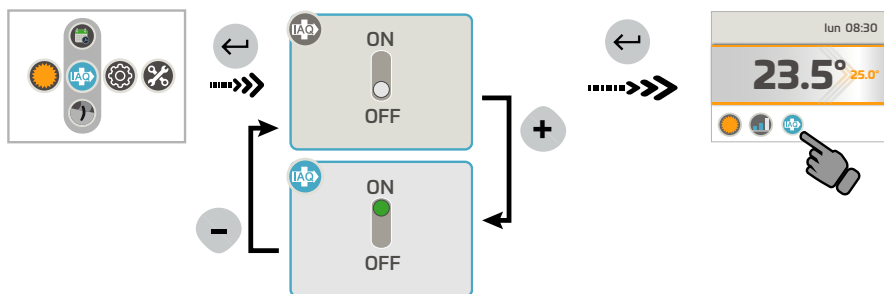

Attivazione FLAP SWING

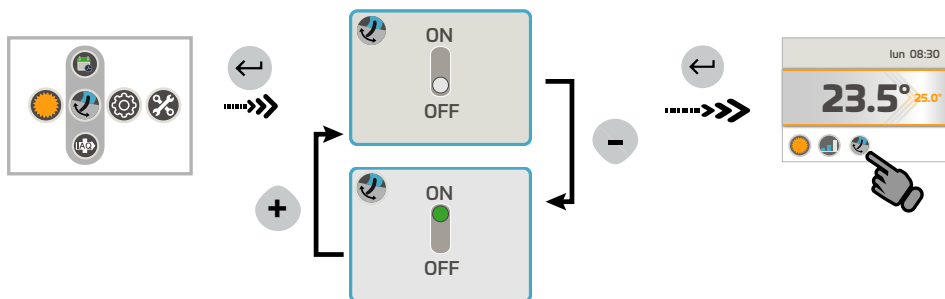

Attivazione modalità NIGHT

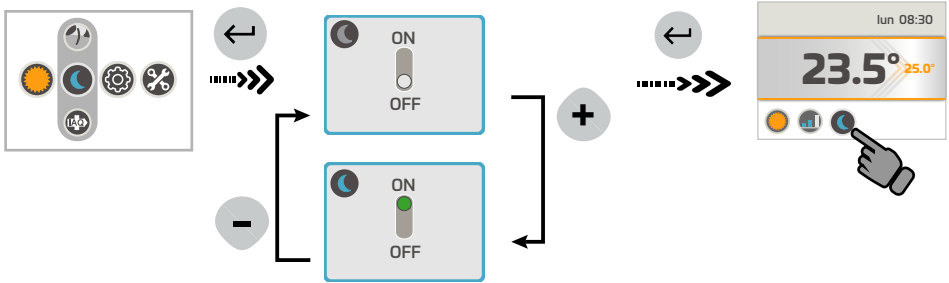

MENU' INFORMAZIONI

Nel Menù *INFORMAZIONI* sarà possibile visualizzare:

- Firmware Comando T-MB 2
- Tipo apparecchio collegato
- Firmware scheda collegata

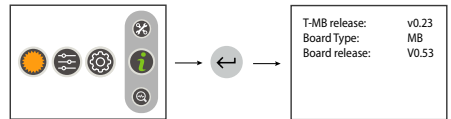

MENU' DIAGNOSTICA

Nel Menù *DIAGNOSTICA* sarà possibile visualizzare lo stato del TMB2, dell'unità a cui è collegato ed eventuali segnalazioni di stato di allarme presenti:

- Stato di allarme (presente solo se vi è un allarme in corso)
- Stato (On/Off)
- Modalità
- Velocità fan
- Stato valvole
- Valori letti dalle sonde (T2/T3 disponibile solo su schede MB in collegamento MASTER)
- Modalità di lavoro speciali (ciclo di antistratificazione, Ciclo Power On
- Stato contatto finestra
- Stato on/off remoto
- Allarme pompa (se disponibile)

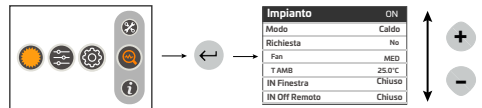

ALLARMI

Versione MB

- AL1 = sonda T1 guasta
- AL2 = sonda T2 guasta
- AL3 = sonda T3 guasta
- AL4 = allarme condensa
- AL6 = Allarme sonda NTC controller
- AL7 = Errore timekeeper
- AL8 = allarme antigelo scheda
- AL9 = cool not possible
- AL10= allarme comunicazione scheda FLAP (se disponibile)
- AL12 = RTC KO (errore timekeeper scheda (se disponibile))
- AL13 = ON / Off remoto

Versione AU

- AL1 = sonda T1 guasta
- AL2 = sonda T2 guasta
- AL3 = sonda T3 guasta
- AL6 = Allarme sonda NTC controller
- AL7 = Errore Timekeeper
- AL9 = cool not possible

Versione LAMA ARIA

- AL1 = sonda T1 guasta
- AL6 = Allarme sonda NTC controller
- AL7 = Errore Timekeeper

MENU' INSTALLATORE

Nel Menù *INSTALLATORE* sarà possibile visualizzare e modificare i parametri di funzionamento del termostato. Scegliere il parametro da modificare premendo i tasti "+" o "-" e confermare con il tasto "M". Una volta selezionato il parametro, il display visualizzerà il valore. Il valore potrà essere modificato attraverso i tasti "+" o "-".

Premendo una sola volta il tasto "M" si torna alla scelta di parametri; per uscire dal menù premere nuovamente il tasto "M".

ATTENZIONE: i parametri disponibili dipendono dalla unità a cui il TMB2 è collegato; in funzione della unità, solo alcuni potrebbero essere disponibili.

FUNZIONE /PARAMETRO	DESCRIZIONE	RANGE/SCelta
+/-3 MODE	Imposta il comando in configurazione +/- 3 (solo MB)	ON = attivazione configurazione +/- 3
T-MB NTC	Seleziona il sensore di temperatura presente sul TMB oppure montato sulla apparecchiatura (T1)	ON = sensore TMB2 OFF = Sensore apparecchio
T DISP	Scelta di visualizzazione della temperatura	TAMB = temperatura ambiente (legata al parametro T-MB NTC) T SET = visualizza la temperatura del SET
°C/°F	modifica dell'unità di misura della temperatura	°C / °F
BMS	Modalità sotto supervisione On/Off	ON - OFF
PIN	Password 4 cifre menù installatore	
T2-1	Cambio stato da ventilazione a raffrescamento	15 ÷ 25°C
T2-2	Cambio stato da ventilazione a riscaldamento	25 ÷ 35°C
I-T2	Isteresi sonda T2	
T3-1	Ventilatore ON in riscaldamento	> 30 ÷ 40°C
T3-2	Ventilatore ON in raffrescamento	< 10 ÷ 25°C
I-T3	Isteresi sonda T3	2 ÷ 6°C
F-t1	tempo attesa antistratificazione	
F-t2	durata post ventilazione	
F-t3	Tempo di post ventilazione	
Irl	Isteresi dei relè	0,5 ÷ 2,0°C
dEdr	Campo di impostazione zona morta	1 ÷ 6°C
t1ds	Scompensazione sonda aria T1 ciclo invernale	0,5 ÷ 2,0°C
Slu1	Tensione min. velocità	1 ÷ 6
Scu2	Tensione med. Velocità	3 ÷ 8
SHu3	Tensione max. velocità	6 ÷ 10
LLSI	Tensione min. velocità per fan auto inverno	1 ÷ 6
HLSI	Tensione max. velocità per fan auto inverno	5 ÷ 10
PFC	Banda proporzionale in raffrescamento	2,0 ÷ 6,0
PFH	Banda proporzionale in riscaldamento	2,0 ÷ 6,0
dS	dS Range di variazione del set con T-MB ± 9°C ± 3°C	± 9°C
Pt1	Tempo di ritardo intervento pompa	0 ÷ 300 sec.
Pt2	Tempo di OFF in Estate	30 ÷ 90 min.
Pt3	Tempo di ON in Estate	0 ÷ 5 min.
LLSE	Tensione min. velocità per fan auto estate	1 ÷ 6
Hlse	Tensione max. velocità per fan auto estate	5 ÷ 10
t1SE	Scompensazione t1 ESTATE	0 ÷ 2,0°C
Ft2E	Durata Antistratificazione ESTATE	0 ÷ 180 sec
t1SI	Scompensazione t1 Inverno	0 ÷ 5,0°C
Ft2I	Durata Antistratificazione INVERNO	0 ÷ 210 sec
tVIS	Scelta tipo visualizzazione temperatura (vers. AU)	0 = Comando a parete 1 = Sonda bordo macchina 2 = set point corrente
dEds	Punto centrale zona morta (vers. AU)	18 ÷ 30°C
RESET	Reset Parametri	

BLOCCO TASTI

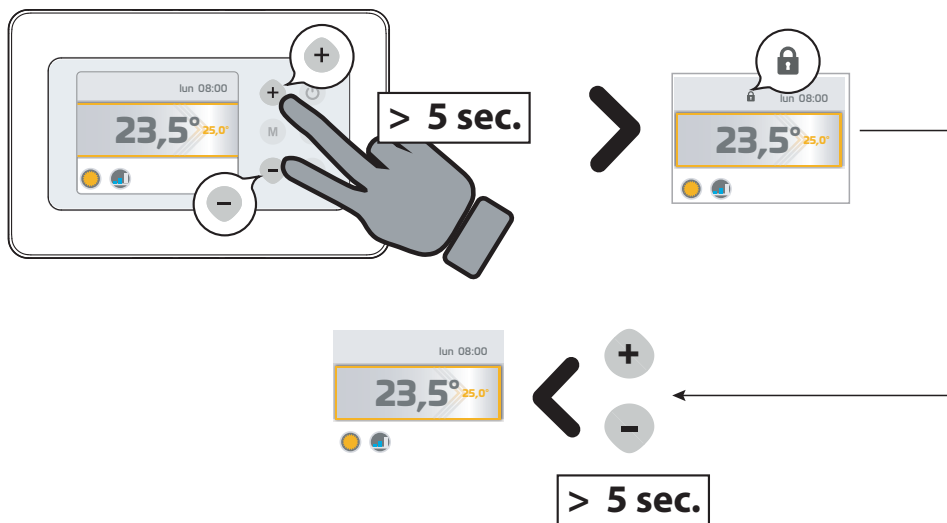

CONTROL WIRING CONNECTIONS

The control panel must be wired to the power board located inside the electrical compartment of the unit, complying with the correspondence of the common numbering to both boards.

Use 3 conductors with 0.5 mm² section.

NOTE: The connection wiring must not exceed 20 metres in length.

ATTENTION: the control must be used exclusively in the combinations with the control units provided from the manufacturer and reported within the manufacturer's documentation.

The control accordance with the relating safety Standards and Directives is assured only and exclusively according to such combinations.

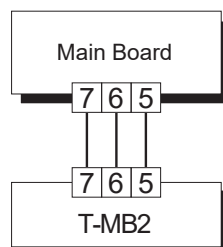

DIP SWITCH SETTING

DEFAULT

DIP 1 = OFF DIP 3 = ON

DIP 2 = OFF DIP 4 = OFF

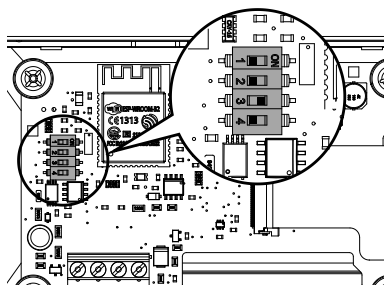



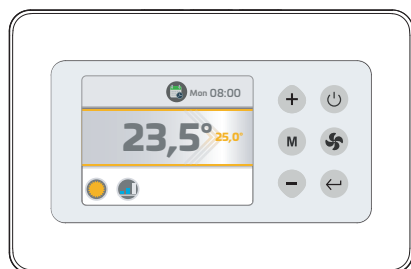

FUNCTION	DIP1	DIP2	DIP3	DIP4
T-MB2 - Unit with MB board	OFF	OFF	ON	OFF
T-MB2 - Unit with AU board	OFF	ON	ON	OFF
T-MB2 - DOOR CURTAIN unit	ON	OFF	ON	OFF

CONTROL OVERVIEW

BUTTONS



-  On/Off (Stand-by)
-  Mode
-  Enter/Return
-  Ventilation
-  Increase/Decrease

DISPLAY

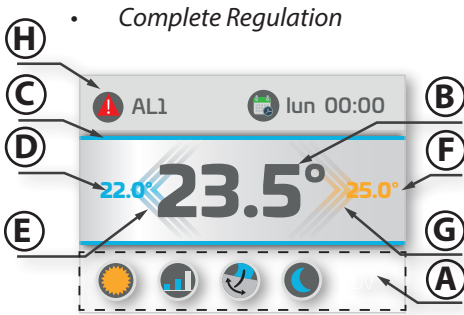

- A. Active function view
- B. Room Temperature
- C. Identification mode :
 - Summer/Cooling = Blue
 - Winter/Heating = Orange

- D. Summer mode set
- E. Summer mode demand status
- F. Winter mode set
- G. Winter mode demand status
- H. Alarm view
- I. View into the +/-3 version (only MB)

SYMBOLS

	Summer - Cooling Mode		Timer Programming		MINIMUM speed (3 step FAN)
	Winter - Heating Mode		Clock set		MEDIUM speed (3 step FAN)
	Automatic Mode		Installer menu		MAXIMUM speed (3 step FAN)
	Ventilation Mode		Information		AUTOMATIC speed
	- Flap Swing activation menu - Active Swing signaling		Troubleshooting Status view		LINEAR speed 1-10 Volt range (if available)
	- IAQ activation menu - Active IAQ Filter signaling		Alarm presence		Stand-by
	- Night mode activation menu - Active Night mode signaling		Active Anti-Stratification Cycle signaling		Language menu
	- Timer activation menu		Active heater signaling		Activated Remote ON/OFF signalling
	- Timer activation 1,2 or 3 - Active Timer signaling (1,2 or 3)		Heater signaling Max. power activation		Activated Window contact signaling (available only with MB boards)
	- Timer APP activation - Active Timer APP signaling		- Not active Timer		

USE OF THE BUTTONS FOR THE BROWSING

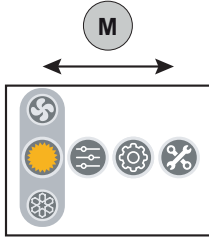

Horizontal shifting :

for shiftings from left to right among the menus press the **M** button. At each pressure a shifting takes place.

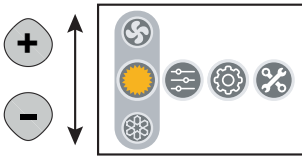

Vertical shifting :

for shiftings from the top down among the menus to choose the operating mode press the **+** **-** buttons. At each pressure a shifting takes place.

To Confirm :

to confirm the choice of the menu or of the operating mode press the **←** button.

OVERVIEW OF THE MENUS

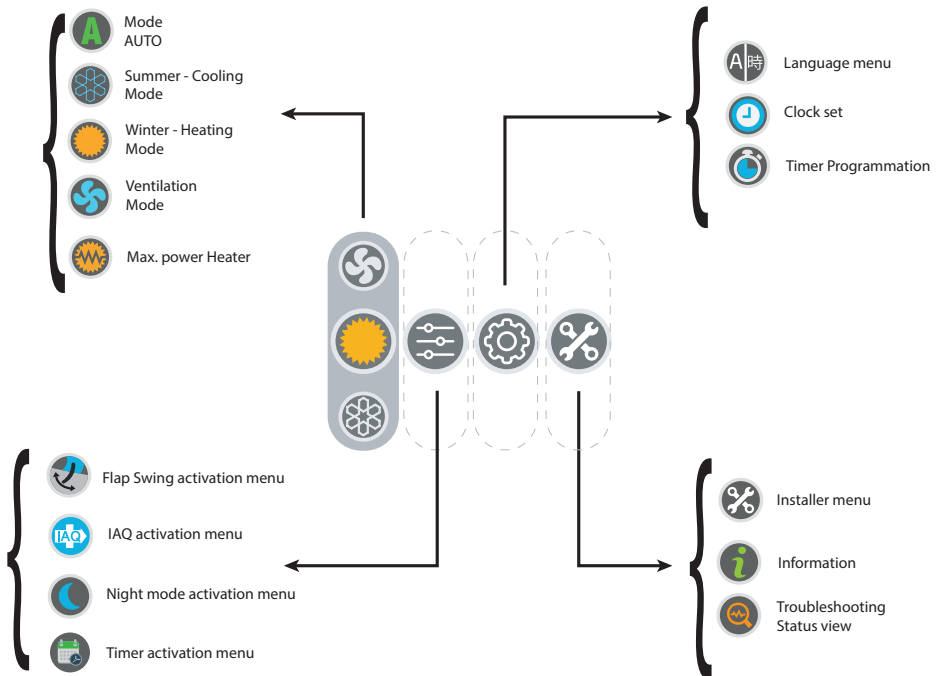

PRIMARY OPERATING MODES

- ON/OFF**

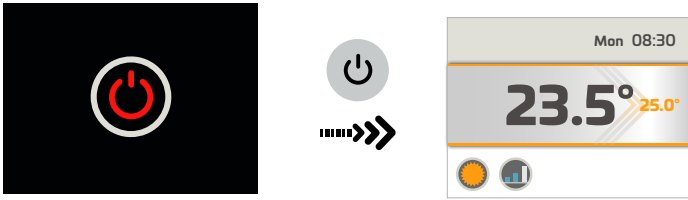

- MODE Configuration**

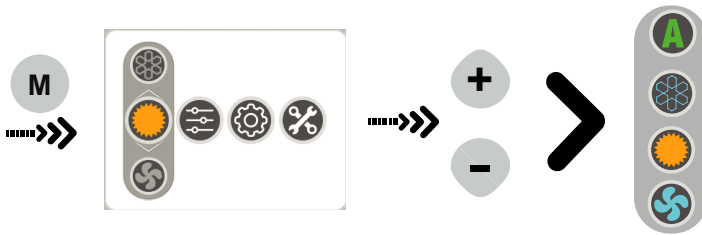

- SET Configuration**

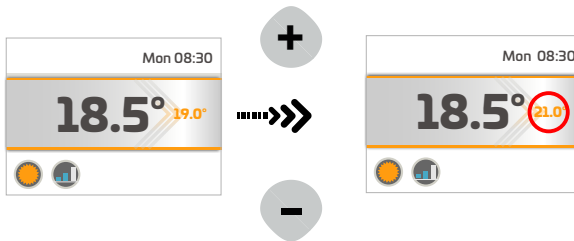

- SPEED Configuration**

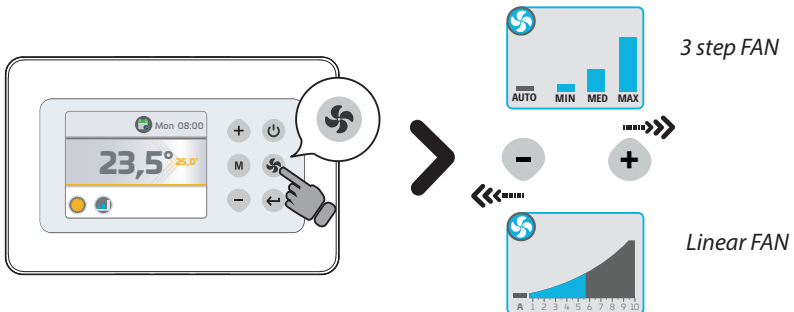

CLOCK SETTING

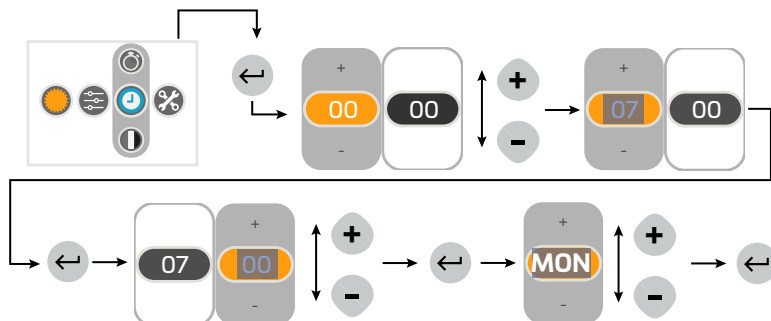

Timer - Activation

There are 4 TIMER programs optionally activable : TIMER1, TIMER 2, TIMER 3, TIMER APP.

TIMER1, TIMER 2, TIMER 3: suitable for setting on the TMB control; follow the instructions reported here below for setup and activation of the 3 programs.

TIMER APP: suitable for recording the TIMER program configured via APP (If available).

To choice what TIMER program (previously set) to activate, follow the instructions reported here below :

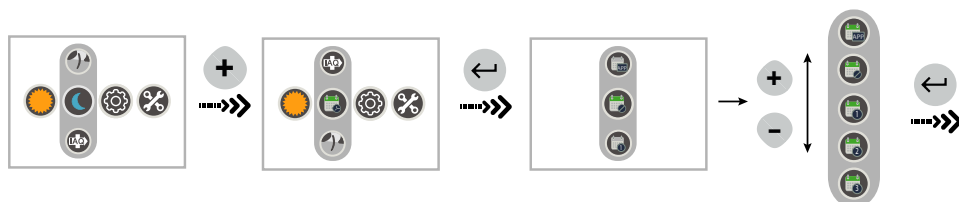

TIMER - Program Setup

As a default all the timers produced are not configured.

IMPORTANT : to proceed with a **TIMER** program setup is necessary first of all to activate it. In case of running the setup without having previously activated a program, the configuration will be automatically stored within the **TIMER 1** program.

To set one ore several **TIMER** programs 1,2,3 :

- 1) Activate the desired program by setting it via the activation menu.
- 2) To access to the configuration menu just follow the instructions reported here below:

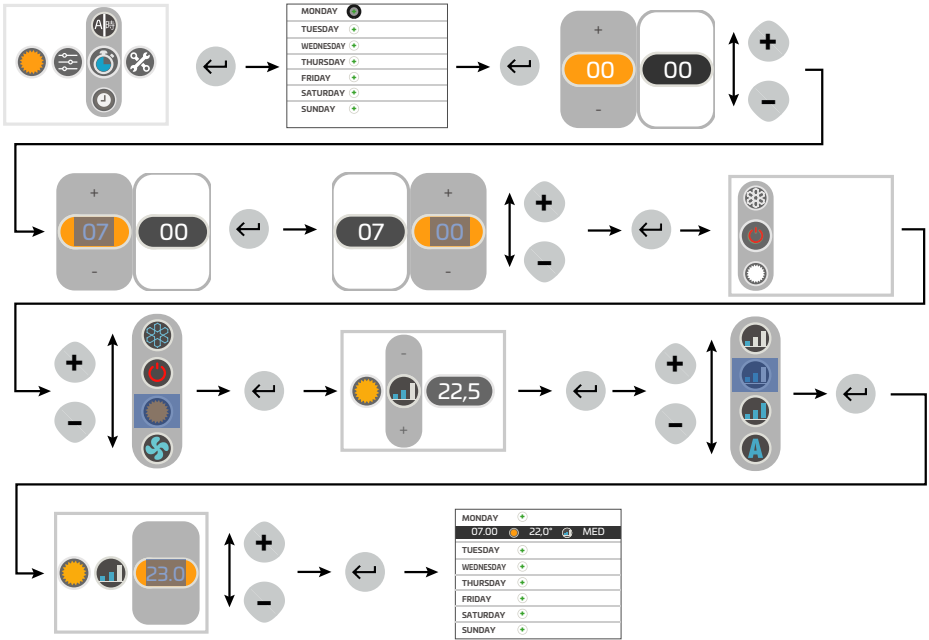

IMPORTANT! Before modifying or deleting a **TIMER** program, it is necessary to activate it in the "Activation" menu (see dedicated chapter).

TIMER - Program change

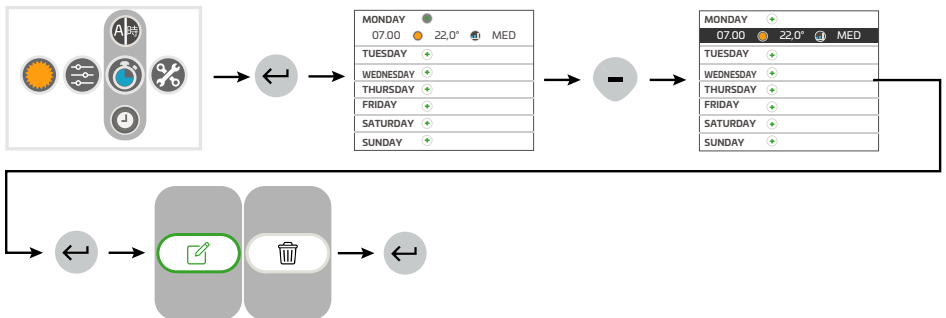

TIMER - Program removal

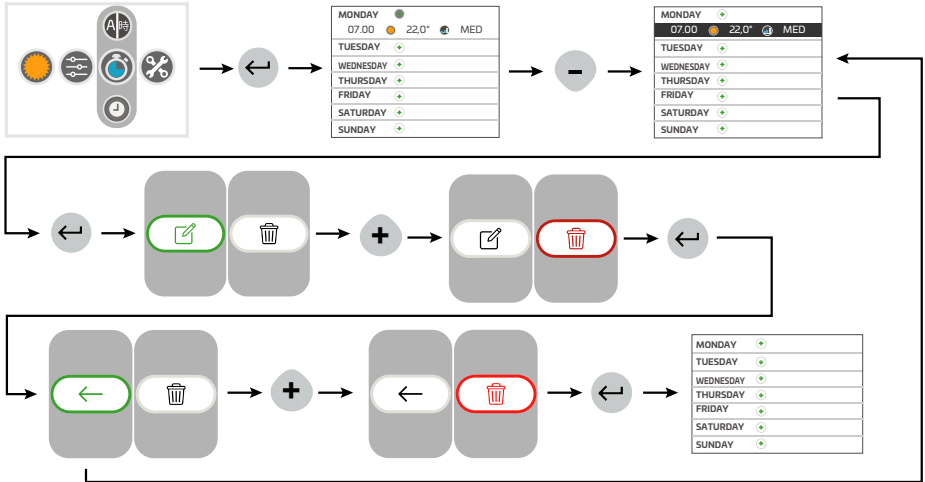

SECONDARY OPERATING MODES

• IAQ Filter activation

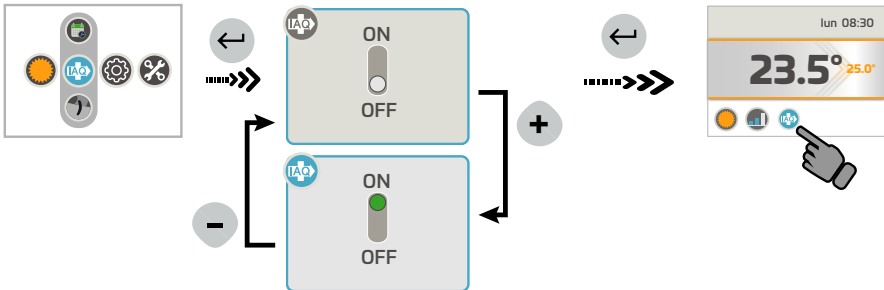

• FLAP SWING activation

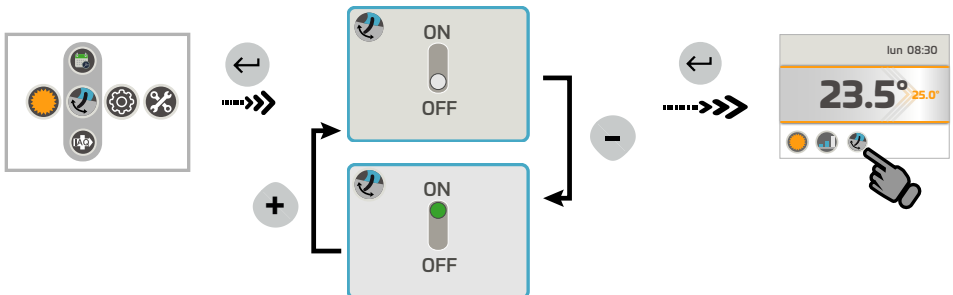

NIGHT mode activation

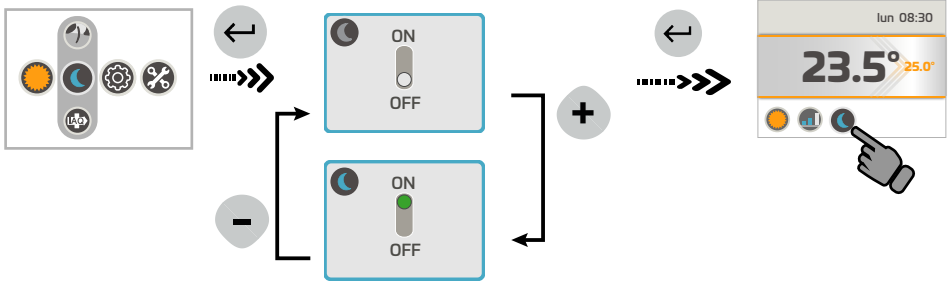

INFORMATION MENU

Within the *INFORMATION* menu it will be possible to view :

- T-MB 2 control Firmware
- Connected unit type
- Connected board Firmware

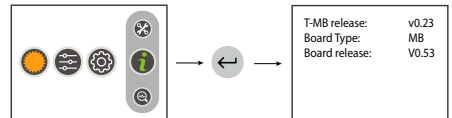

TROUBLESHOOTING MENU

In the *TROUBLESHOOTING* menu it will be possible to view the status of the TMB2 control, of the unit to which it is connected and probable signalings of alarm status presence :

- Alarm status (operating only if an alarm is on)
- Status (On/Off)
- Mode
- Fan speed
- Valve status
- Values detected by the probes (T2/T3 available only on MB boards into MASTER connection)
- Special operating modes (anti-stratification cycle, Power On cycle.....)
- Window contact status
- Remote on/off status
- Pump alarm (if available)

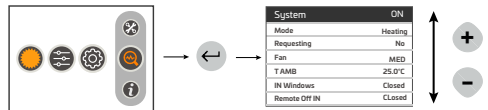

ALARMS

MB Version

- AL1 = T1 faulty probe
- AL2 = T2 faulty probe
- AL3 = T3 faulty probe
- AL4 = Condensate alarm
- AL6 = NTC probe alarm controller
- AL7 = Timekeeper error
- AL8 = Anti-freeze board alarm
- AL9 = Cooling not possible
- AL10= FLAP board communication alarm (if available)
- AL12 = RTC KO (timekeeper board error (if available)
- AL13 = Remote ON / Off

AU Version

- AL1 = T1 faulty probe
- AL2 = T2 faulty probe
- AL3 = T3 faulty probe
- AL6 = NTC probe alarm controller
- AL7 = Timekeeper error
- AL9 = Cooling not possible

Air curtain version

- AL1 = T1 faulty probe
- AL6 = NTC probe alarm controller
- AL7 = Timekeeper error

INSTALLER MENU

With the *INSTALLER menu* it will be possible to view and modify the thermostat operating parameters. Choose the parameter to modify by pressing the “+” or “-” buttons and confirm with the “M” button. Once the parameter is selected, the display will show the value. It will be possible to modify the value by pressing the “+” or “-” buttons.

Press the “M” button only one time to turn back to the parameter choice; to get out from the menu, press the “M” button again.

ATTENTION: the available parameters depend from the unit to which the T-MB2 is connected; according to the unit, only a few ones could be available.

FUNCTION /PARAMETER	DESCRIPTION	RANGE
<u>+/-3 MODE</u>	Set the control into the +/- 3 configuration (only MB)	ON = +/- 3 configuration activation
<u>T-MB NTC</u>	Select the temperature probe fitted on the TMB or on the unit (T1)	ON = TMB2 probe OFF= Unit probe
<u>T DISP</u>	Temperature view choice	TAMB = room temperature (related to the T-MB NTC parameter) T SET = view the SET temperature
<u>°C/°F</u>	Temperature unit of mesure change	°C / °F
<u>BMS</u>	On/Off under supervision mode	ON - OFF
<u>PIN</u>	4-digit installer menu password	
<u>T2-1</u>	Status change from ventilation to cooling	15 ÷ 25°C
<u>T2-2</u>	Status change from ventilation to heating	25 ÷ 35°C
<u>I-T2</u>	T2 probe hysteresis	
<u>T3-1</u>	Fan ON in heating	> 30 ÷ 40°C
<u>T3-2</u>	Fan ON in cooling	< 10 ÷ 25°C
<u>I-T3</u>	T3 probe hysteresis	2 ÷ 6°C
<u>F-t1</u>	Anti-stratification waiting time	
<u>F-t2</u>	Post ventilation duration	
<u>F-t3</u>	Post ventilation time	
<u>Irl</u>	Hysteresis of relays	0,5 ÷ 2,0°C
<u>dEdr</u>	Dead zone setup field	1 ÷ 6°C
<u>t1ds</u>	T1 air probe decompensation winter cycle	0,5 ÷ 2,0°C
<u>Slu1</u>	Min. speed tension	1 ÷ 6
<u>Scu2</u>	Med. speed tension	3 ÷ 8
<u>SHu3</u>	Max. speed tension	6 ÷ 10
<u>LLSI</u>	Min. speed tension for fan auto winter	1 ÷ 6
<u>HLSI</u>	Max. speed tension for fan auto winter	5 ÷ 10
<u>PFC</u>	Proportional band in cooling	2,0 ÷ 6,0
<u>PFH</u>	Proportional band in heating	2,0 ÷ 6,0
<u>dS</u>	dS Set Variation Range with T-MB ± 9°C ± 3°C	± 9°C
<u>Pt1</u>	Pump intervention delay time	0 ÷ 300 sec.
<u>Pt2</u>	OFF time in Summer	30 ÷ 90 min.
<u>Pt3</u>	ON time in Summer	0 ÷ 5 min.
<u>LLSE</u>	Min. speed tension for fan auto summer	1 ÷ 6
<u>HLSE</u>	Max. speed tension for fan auto summer	5 ÷ 10
<u>t1SE</u>	T1 air probe decompensation SUMMER	0 ÷ 2,0°C
<u>Ft2E</u>	Anti-stratification time SUMMER	0 ÷ 180 sec
<u>t1sl</u>	T1 air probe decompensation WINTER	0 ÷ 5,0°C
<u>Ft2I</u>	Anti-stratification time WINTER	0 ÷ 210 sec
<u>tVIS</u>	Temperature view type choice (Vers. AU)	0 = Wall control 1 = Probe fitted on the unit 2 = Current setpoint
<u>dEds</u>	Dead zone central point	18 ÷ 30°C
<u>RESET</u>	Reset Parameters	

KEY LOCK

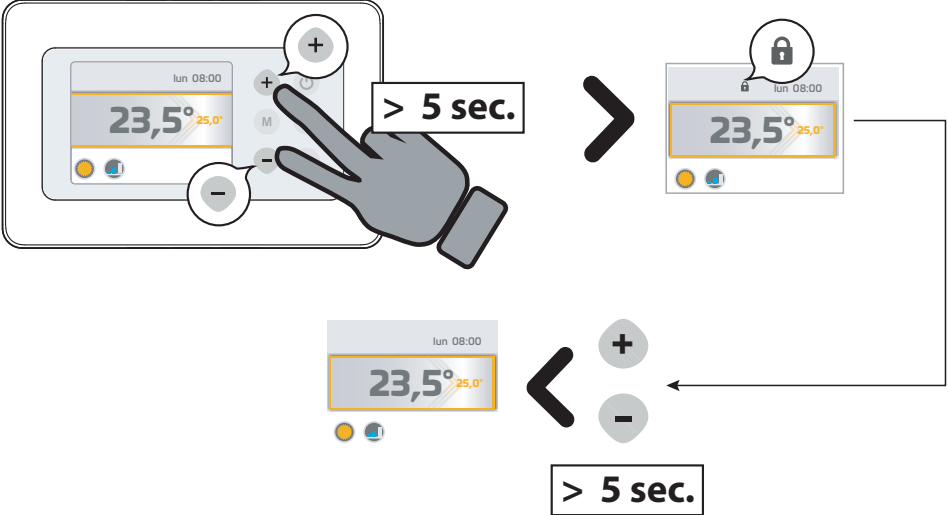

RACCORDEMENTS ELECTRIQUES DE LA COMMANDE

Le panneau de commandes doit être branché électriquement à la carte de puissance située à l'intérieur de l'appareil électrique de l'unité, en respectant la correspondance de la numérotation commune à l'ensemble des cartes.

Utiliser 3 conducteurs avec section 0,5 mm².

NOTE : La longueur du câble de raccordement ne doit pas dépasser 20 mètres.

ATTENTION: la commande doit être utilisée uniquement en combinaisons avec les unités livrées par le fabricant et citées dans la documentation du fabricant même.

La conformité de la commande avec les Normes et Directives de sécurité applicables est assurée uniquement et exclusivement selon telles combinaisons.

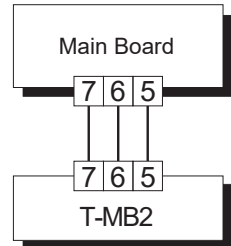

PROGRAMMATION DES DIPSWITCHES

DEFAULT

DIP 1 = OFF DIP 3 = ON

DIP 2 = OFF DIP 4 = OFF

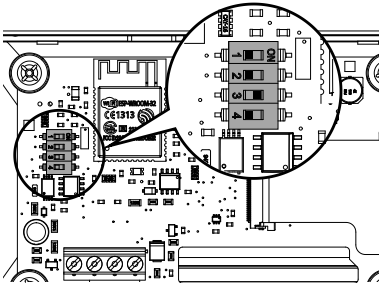

FUNCTION	DIP1	DIP2	DIP3	DIP4
T-MB2 – unité avec carte MB	OFF	OFF	ON	OFF
T-MB2 – unité avec carte AU	OFF	ON	ON	OFF
T-MB2 – unite RIDEAU D'AIR	ON	OFF	ON	OFF

VUE D'ENSEMBLE COMMANDE

TOUCHES

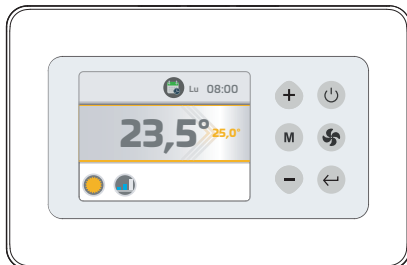

 On/Off (Stand-by)

 Mode

 Enter/Retour

 Ventilation

 + - Accroître / Diminution

AFFICHAGE

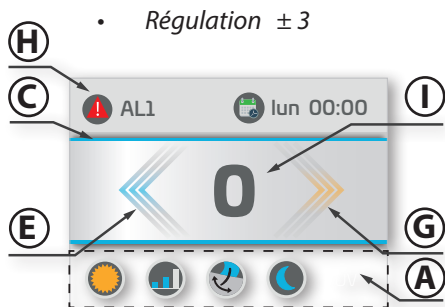
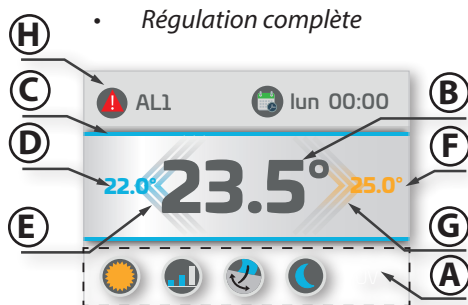

- A. Affichage des fonctions actives
 B. Température Ambiante
 C. Identification mode:
 • Été/Refroidissement = Bleu
 • Hiver/Chauffage = Orange

- D. Set mode Été
 E. Etat de demande mode Été
 F. Set mode Hiver
 G. Etat de demande mode Hiver
 H. Affichage Alarmes
 I. Affichage en version +/-3
 (uniquement MB)

SYMBOLES

	Mode Été – Refroidissement		Programmation Timer		Vitesse MINIMALE (VENTILATEUR à 3 étapes)
	Mode Hiver – Chauffage		Programmation Horloge		Vitesse MOYENNE (VENTILATEUR à 3 étapes)
	Mode Automatique		Menu Installateur		Vitesse MAXIMALE (VENTILATEUR à 3 étapes)
	Mode Ventilation		Informations		Vitesse AUTOMATIQUE
	- Menu activation Flap Swing - Signalisation Swing Actif		Dépannage Visualisation état		Vitesse LINEAIRE éventail 1-10 Volt (si disponible)
	- Menu activation IAQ - Signalisation Filtre IAQ Actif		Présence Alarme		Stand-by
	- Menu activation mode Nuit - Signalisation mode Nuit Actif		Signalisation Cycle Anti-stratification Actif		Menu Language
	- Menu activation Timer		Signalisation Résistance Active		Signalisation mode ON/OFF à distance actif
	- Activation Timer 1,2 ou 3 - Signalisation Timer Actif (1,2 ou 3)		Signalisation Résistance Active Max. Puissance		Signalisation Contact Fenêtre actif (disponible uniquement avec les cartes MB)
	- Activation Timer APP - Signalisation Timer APP Actif		- Timer pas actif		

USAGE DES TOCHES POUR LA NAVIGATION

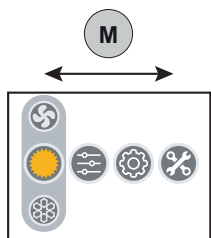

Déplacement horizontal :

Pour les déplacements horizontaux de gauche à droite appuyer entre les menus la touche **M**.
A chaque pression on a un déplacement.

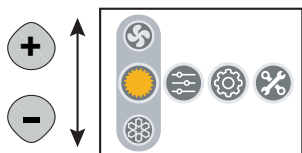

Déplacement vertical :

Pour les déplacements de haut en bas dans les menus pour le choix des modes opératifs appuyer les touches **+** **-**.
A chaque pression on a un déplacement.

Pour Confirmer:



pour confirmer le choix du menu ou du mode opératif appuyer la touche **←**.

VUE D'ENSEMBLE DES MENUS

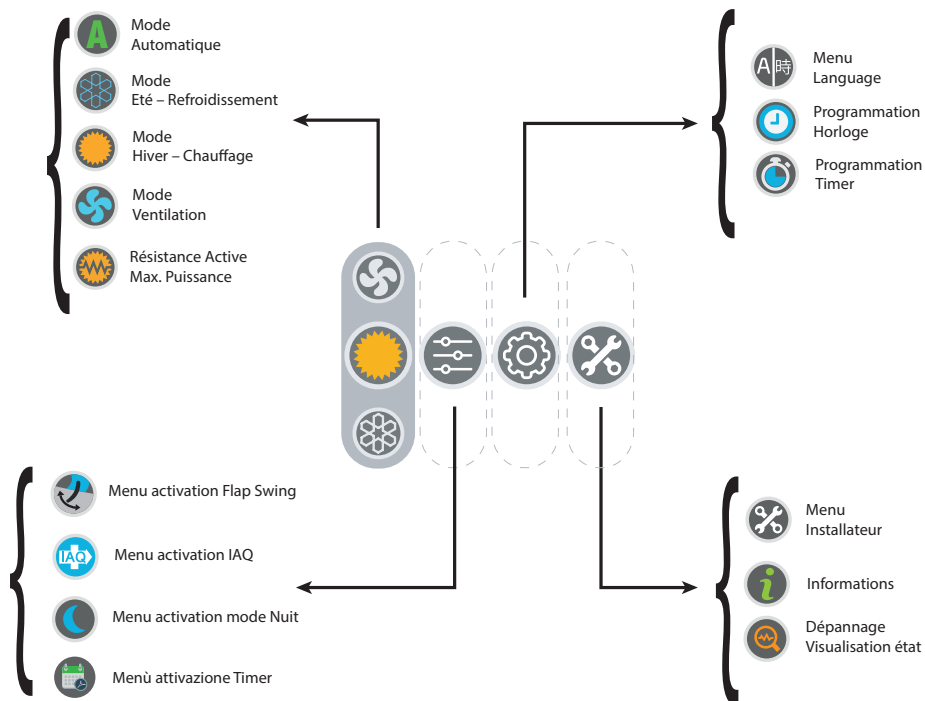

MODES OPÉRATIFS PRIMAIRES

• **ON/OFF**

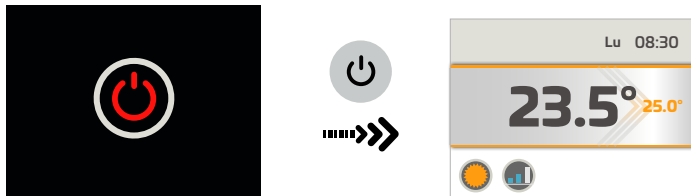

• **Configuration MODE**

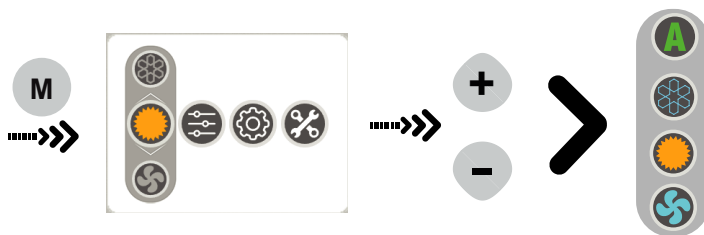

• **Configuration SET**

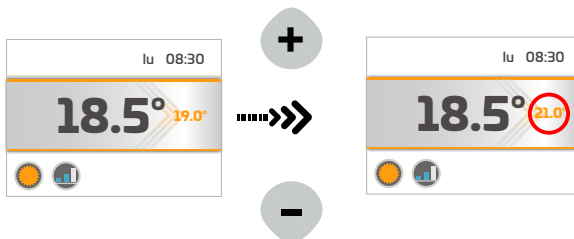

• **Configuration VITESSE**

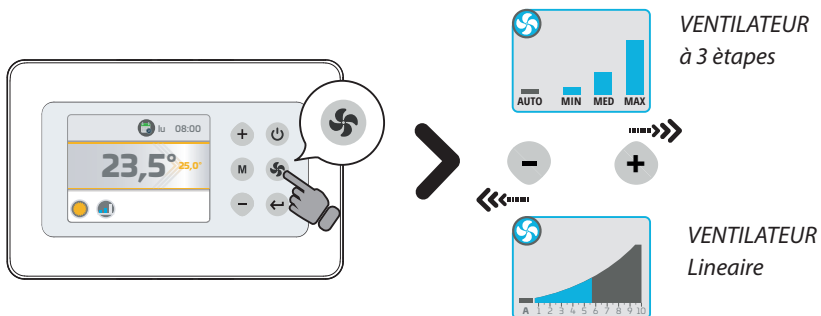

PROGRAMMATION HORLOGE

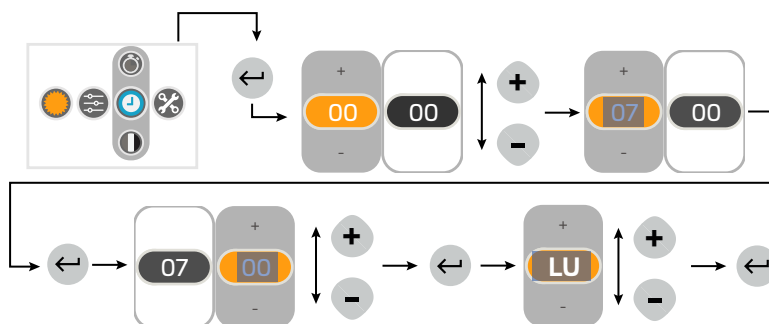

TIMER - Activation

On peut choisir entre 4 programmes Timer activables : TIMER1, TIMER 2, TIMER 3, TIMER APP.

TIMER1, TIMER 2, TIMER 3 : servent à la programmation sur la commande ; suivre les instructions ci-dessous pour programmation et activation des 3 programmes.

TIMER APP: sert à l'enregistrement du programme TIMER programmé via APP (si disponible).

Afin de choisir le programme TIMER (précédemment mis en place) à activer, se référer à l'instruction ci-dessous:

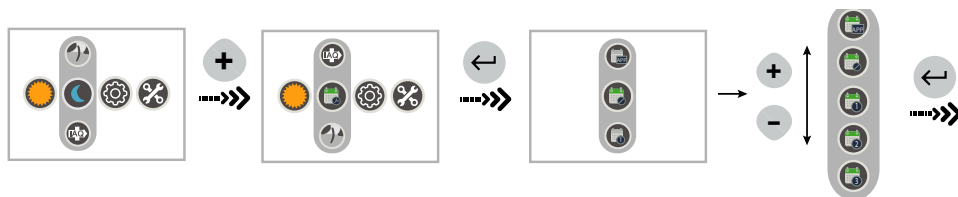

TIMER - Configuration Programme

Chaque TIMER vient fabriqué non configuré.

IMPORTANT : Pour la configuration d'un programme TIMER il est nécessaire en premier lieu qu'il soit activé. Si la programmation vient effectuée sans avoir précédemment activé aucun programme, la configuration vient automatiquement sauvée dans le programme TIMER 1.

Pour la configuration de un ou plusieurs programmes TIMER 1,2,3 :

- 1) Activer le programme à configurer dans le menu Activation.
- 2) Accéder au menu configuration en suivant les instructions ci-dessous :

Français

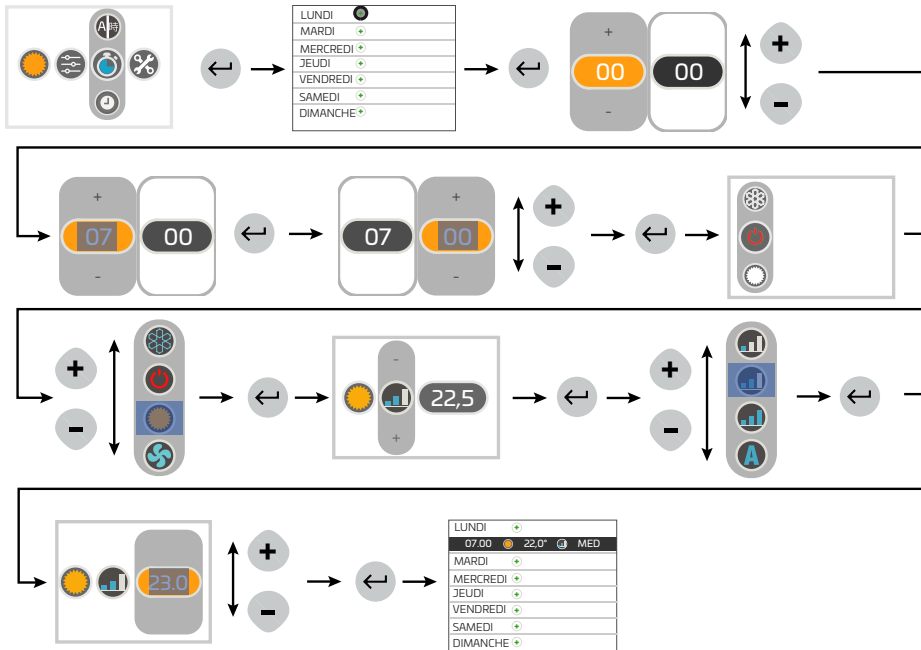

IMPORTANT! Avant de modifier ou supprimer un programme **TIMER** il faut qu'il soit activé dans le menu Activation (voir le chapitre dédié).

TIMER – Modification Programme

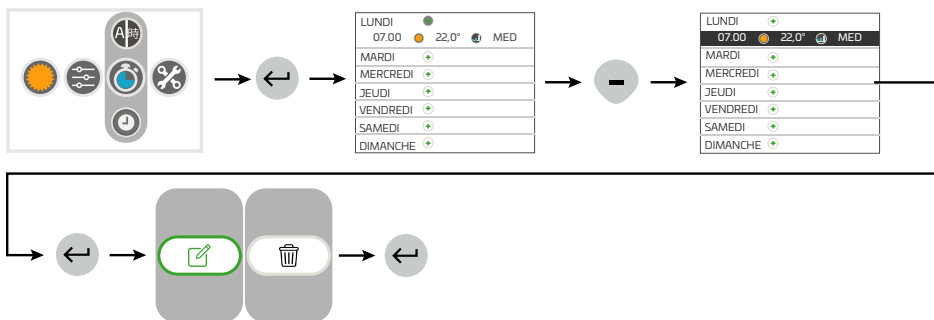

TIMER - Suppression Programme

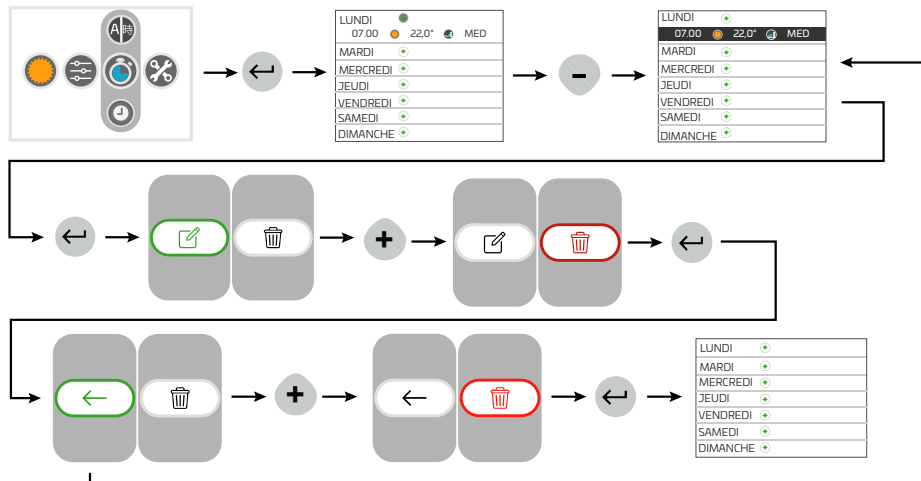

MODES OPÉRATIFS SECUNDAIRES

- Activation Filtre IAQ**

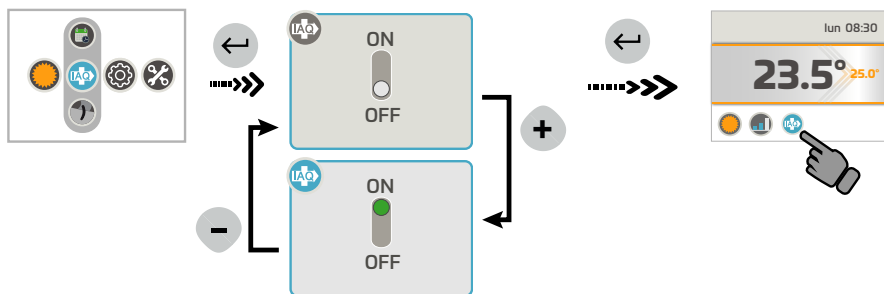

- Activation FLAP SWING**

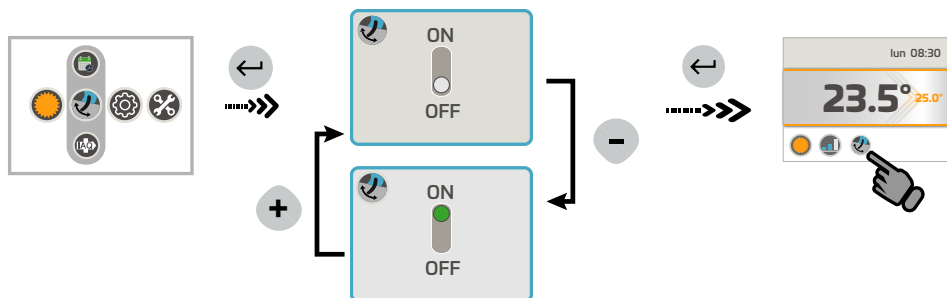

• Activation mode NUIT

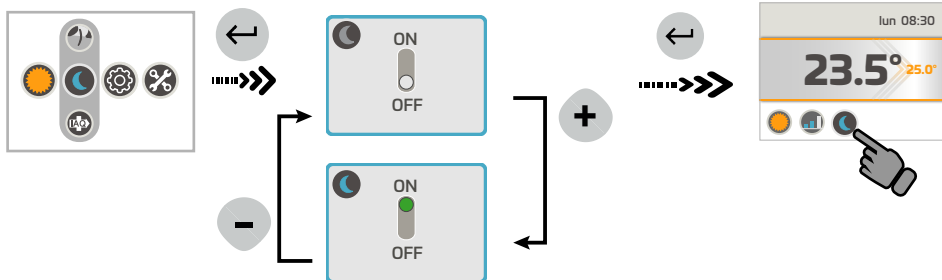

MENU INFORMATIONS

Dans le Menu INFORMATIONS on pourra afficher :

- Firmware Commande T-MB 2
- Type d'unité liée
- Firmware carte liée

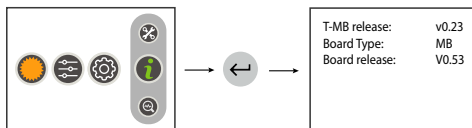

MENU DÉPANNAGE

Dans le menu DéPANNAGE on pourra afficher l'état de la commande T-MB2, de l'unité à laquelle elle est liée et eventuelles signalisations d'état Alarme présentes :Stato di allarme (presente solo se vi è un allarme in corso)

- Etat d'Alarme (présent seulement s'il y a un en cours)
- Etat (On/Off)
- Modalité
- Vitesse ventilateur
- Etat des vannes

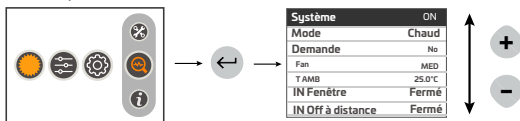

- Valeurs luës par les capteurs (T2/T3 disponible uniquement sur régulateurs MB en connexion MASTER)
- Modalités opératives spéciales (cycle de anti-stratification, Cycle Power On
- Etat contacte fenêtre
- Etat on/off à distance
- Alarme pompe (si disponible)

ALARMES

• Version MB

- AL1 = Capteur T1 défectueux
- AL2 = Capteur T2 défectueux
- AL3 = Capteur T3 défectueux
- AL4 = Alarme condensats
- AL6 = Alarme capteur NTC controller
- AL7 = Erreur timekeeper
- AL8 = Alarme carte antigel
- AL9 = On ne peut pas refroidir
- AL10= Alarme communication carte FLAP (si disponible)
- AL12 = RTC KO (erreur carte timekeeper (si disponible)
- AL13 = ON / Off à distance

• Version AU

- AL1 = capteur T1 défectueux
- AL2 = capteur T2 défectueux
- AL3 = capteur T3 défectueux
- AL6 = Alarme capteur NTC controller
- AL7 = Erreur Timekeeper
- AL9 = on ne peut pas refroidir

• Version Rideaux d'air

- AL1 = capteur T1 défectueux
- AL6 = Alarme capteur NTC controller
- AL7 = Erreur Timekeeper

MENU INSTALLATEUR

Dans le Menu *INSTALLATEUR* on pourra afficher et modifier les paramètres de fonctionnement du thermostat. Choisir le paramètre à modifier en appuyant les touches "+" ou "-" et confirmer avec la touche « M ». Lorsque le paramètre a été sélectionné, l'afficher ira visualiser la valeur. La valeur pourra être modifiée à travers les touches "+" ou "-".

En appuyant seulement une fois la touche « M » on retourne au choix des paramètres ; pour sortir du menu, appuyer de nouveau la touche « M ».

ATTENTION: les paramètres disponibles dépendent de l'unité à laquelle le T-MB2 est connecté; selon l'unité, seuls quelques-uns peuvent être disponibles.

FONCTION/ PARAMÈTRE	DESCRIPTION	EVENTAIL/CHOIX
+/-3 MODE	Programme la commande en configuration +/- 3 (uniquement MB)	ON = activation configuration +/- 3
T-MB NTC	Sélectionne le capteur de température présent en T-MB ou monté sur l'unité (T1)	ON = capteur TMB2 OFF= capteur unité
T DISP	Choix d'affichage de la température	TAMB = température ambiante (liée au paramètre T-MB NTC) T SET = visualise la température du SET
°C/°F	modifie l'unité de mesure de la température	°C / °F
BMS	Modalité sous supervision On/Off	ON - OFF
PIN	Mot de passe du menu installateur à 4 chiffres	
T2-1	Changement de l'état de ventilation à refroidissement	15 ÷ 25°C
T2-2	Changement de l'état de ventilation au chauffage	25 ÷ 35°C
I-T2	Hystérésis du capteur T2	
T3-1	Ventilateur MARCHE en mode chauffage	> 30 ÷ 40°C
T3-2	Ventilateur MARCHE en mode refroidissement	< 10 ÷ 25°C
I-T3	Hystérésis du capteur T3	2 ÷ 6°C
F-t1	Temps d'atteinte anti-stratification	
F-t2	Durée après-ventilation	
F-t3	Temps d'après-ventilation	
Irl	Hystérésis des relais	0,5 ÷ 2,0°C
dEdr	Champ de réglage de la zone morte	1 ÷ 6°C
t1ds	Décompensation du capteur air T1 cycle hivernal	0,5 ÷ 2,0°C
Slu1	Tension min. vitesse	1 ÷ 6
Scu2	Tension moy. vitesse	3 ÷ 8
SHu3	Tension max. vitesse	6 ÷ 10
LLSI	Tension min. vitesse pour fan auto hiver	1 ÷ 6
HLSI	Tension max. vitesse pour fan auto hiver	5 ÷ 10
PFC	Bande proportionnelle en refroidissement	2,0 ÷ 6,0
PFH	Bande proportionnelle en chauffage	2,0 ÷ 6,0
dS	dS Réglage de gamme de variation du SET avec T-MB ± 9°C ± 3°C	± 9°C
Pt1	Temps de délai intervention pompe	0 ÷ 300 sec.
Pt2	Temps ARRÊT en Été	30 ÷ 90 min.
Pt3	Temps MARCHE en Été	0 ÷ 5 min.
LLSE	Tension min. vitesse pour fan auto été	1 ÷ 6
HLSE	Tension max. vitesse pour fan auto été	5 ÷ 10
t1SE	Décompensation du capteur air T1 ÉTÉ	0 ÷ 2,0°C
Ft2E	Temps anti-stratification ÉTÉ	0 ÷ 180 sec
t1sl	Décompensation du capteur air T1 HIVER	0 ÷ 5,0°C
Ft2I	Temps anti-stratification HIVER	0 ÷ 210 sec
tVIS	Choix type d'affichage température (Vers. AU)	0 = Commande murale 1 = Capteur intégré en l'unité 2 = Point de consigne courant
dEds	Point central de zone morte	18 ÷ 30°C
RESET	Réinitialiser les paramètres	

VERROUILLAGE DES TOUCHES

